

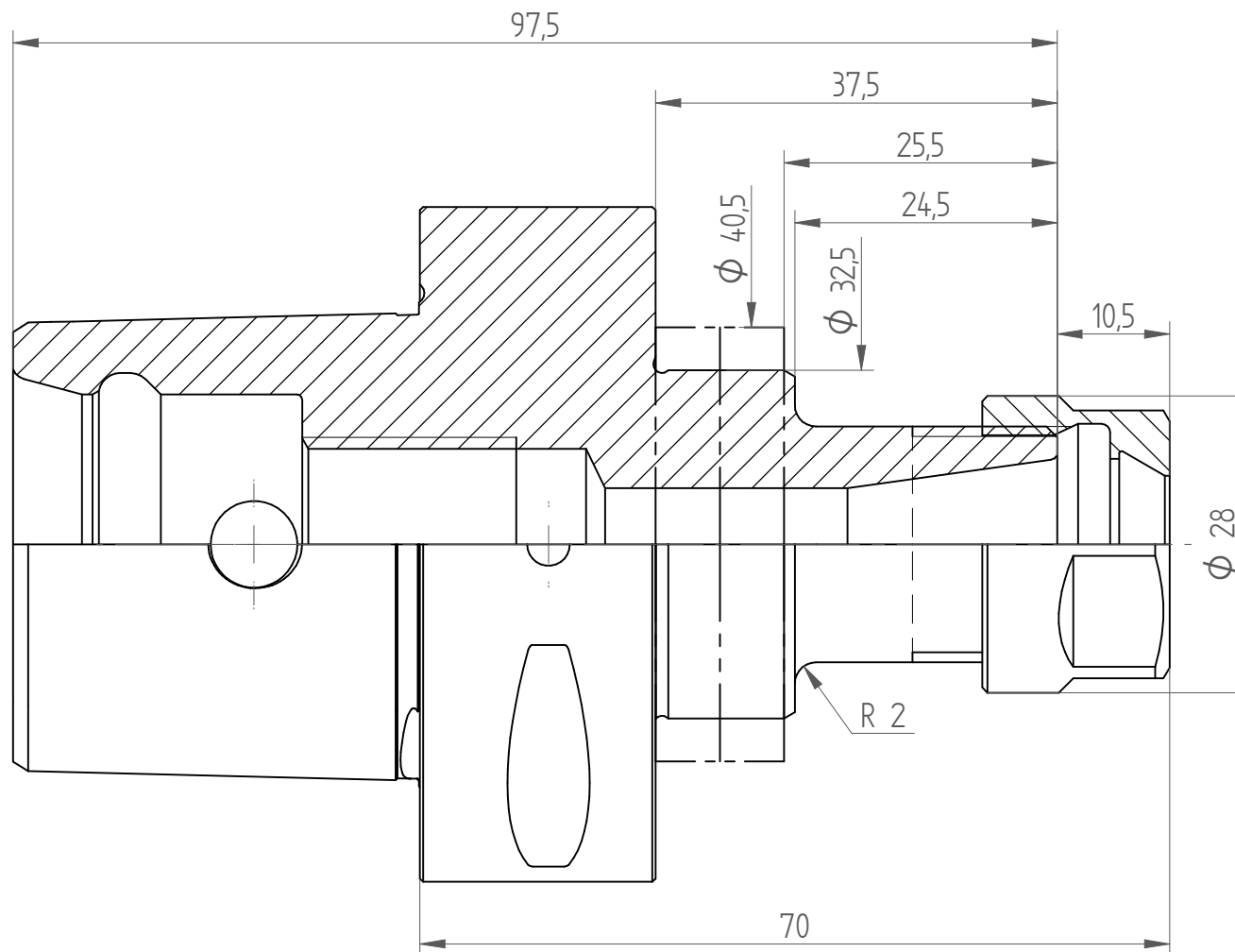

Swiss  
Precision  
Tools

# REGO-FIX®

ER type toolholders are supplied without back-up screws.  
Back-up screws will be supplied upon request.  
With your back-up screw order, part no. (X) and LOT no. (Y) XXXX.XXXXX.YYY of the toolholder are mandatory required.  
Die Lieferung der ER-Spannzangenahmen erfolgt ohne Anschlagsschrauben.  
Anschlagsschrauben werden auf Anfrage geliefert.  
Eine Bestellung von Anschlagsschrauben bedingt zwingend die Angabe der Art. Nr. (X) und LOT Nr. (Y) XXXX.XXXXX.YYY der Spannzangenaufnahme.



REGO-FIX AG  
Obermattweg 60  
4456 Tenniken / Switzerland

Phone +41 61 976 14 66  
Fax +41 61 976 14 14  
www.rego-fix.com

This is a non-controlled copy. All information given herein is subject to change without notice

The information given herein has been carefully checked and is believed to be correct. REGO-FIX, however, assumes no responsibility or liability for any errors, inaccuracies or omissions that may appear in this drawing

This document is subject to copyright laws. No part of this document may be reproduced or transmitted in any form or any means, electronic or mechanic, for any purpose, without the express written permission of REGO-FIX

Type : C6\_ER16x070\_H  
Part No. : 480611630  
Date : 17.04.2014  
Scale : 1.5:1